

Haven

Lounges



burgtec.

Endless options, endless style.

The Haven Lounge is the very definition of flexibility. Its contemporary, modular design inspires businesses to create the workspaces of tomorrow, with endless combinations to cater for every work style and purpose.

Featuring lounges and ottomans in an array of sizes, the Haven Lounge can be combined and customised for a specific space or purpose.



Features

- Made in Australia • Modular lounge system
- Available in ottoman, standard, medium & tall back
- Available in convex, concave & straight modules
- Available in 1, 2 and 3 seater modules

Options

- Option to add arms
- Option to add 300mmD rear work bench
- Option to add GPO units

Finishes

- Unique 170mm high Black Foot: option to custom powdercoat
- Burgtec house fabric range
- Two-tone upholstery available

CUSTOMISED CONFIGURATIONS

The original Haven – a compact, modular system with a tapered back, covering linear, curved and corner modules for an infinite number of custom configurations.

Whether its a casual 'huddle', a quiet break or seating for a high traffic area, Haven options provide the flexibility to suit any environment.

While the Haven 'Tall' serves as a flexible way to divide spaces, the ottoman modules complete the range and can be placed loose or included in larger configurations.



AUSTRALIAN MADE

Burgtec is serious about manufacturing furniture here in Australia using locally sourced materials. It just makes sense in order to provide world-class furniture with quicker lead times and true sustainability.

Over the last 24 months in particular, the team embarked on a comprehensive redesign challenge – to completely rethink the internal structure of our soft seating collection to an even higher quality and comfort, without impacting the products appearance. Starting with the modular Haven lounge, the result is an impressive 30% reduction in materials used.

Designed and Manufactured locally, Haven lounges are available within a 4-6 week lead time.



LOCAL FINISHES

Burgtec's wide range of local house fabrics are available with no extra lead time.

With hundreds of options available, each Haven lounge can be uniquely cohesive with its environment, without the worry of possible supply chain delays.



DIMENSIONS (MM) - HAVEN STANDARD BACK

1 Seater Straight



HAV-SB-1SST

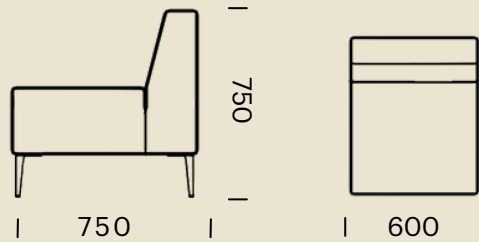

1 Seater 90deg Corner



HAV-SB-CNR

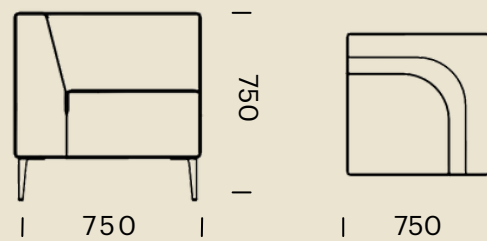

45 Degree Concave



HAV-SB-45CAV

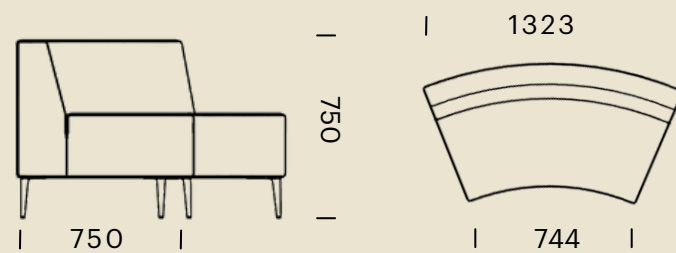

45 Degree Convex

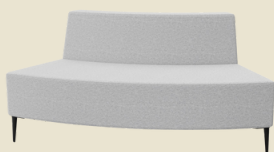

HAV-SB-45CVX

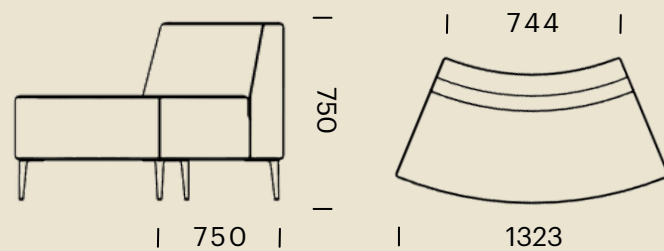

DIMENSIONS (MM) - HAVEN STANDARD BACK

2 Seater Straight



HAV-SB-2SST

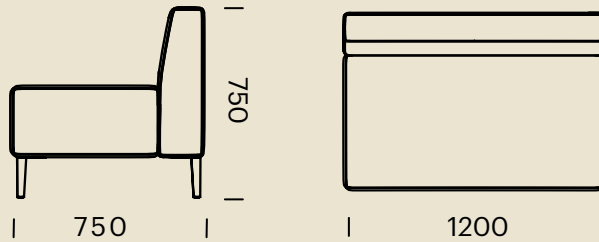

2 Seater with Left & Right Arms



HAV-SB-2SLR

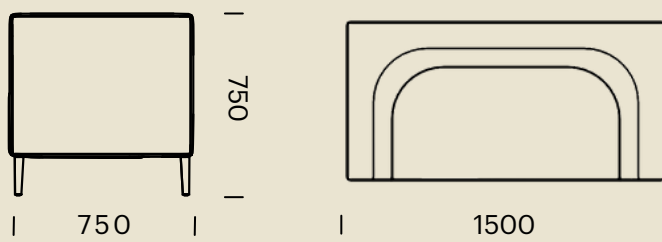

2 Seater with Left Arm



HAV-SB-2SL

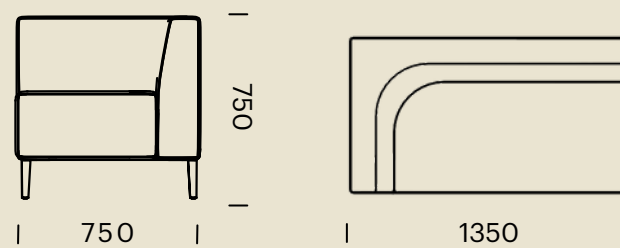

2 Seater with Right Arm

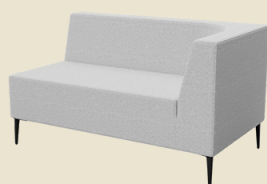

HAV-SB-2SR

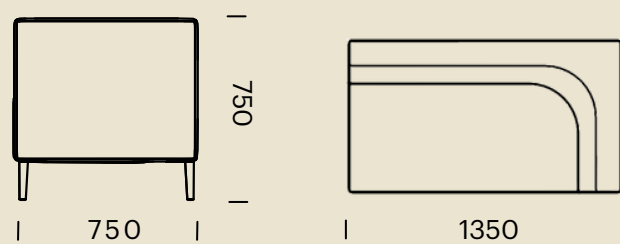

**DIMENSIONS (MM) -
HAVEN STANDARD BACK**

3 Seater Straight

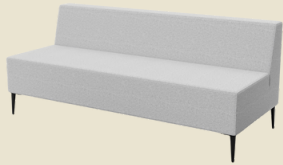

HAV-SB-3SST

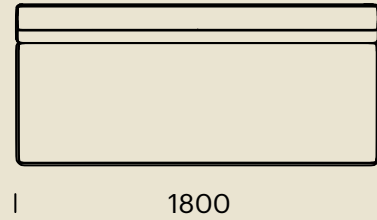
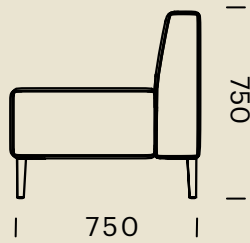

3 Seater with Left & Right Arms

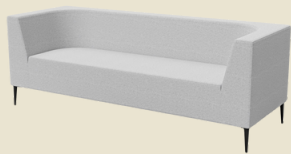

HAV-SB-3SLR

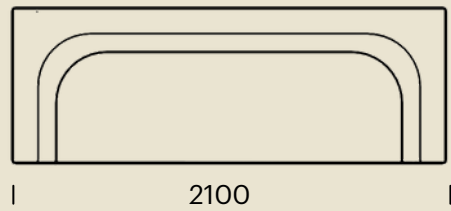
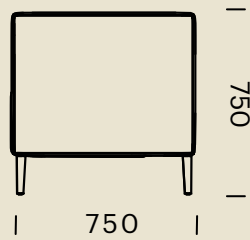

3 Seater with Left Arm

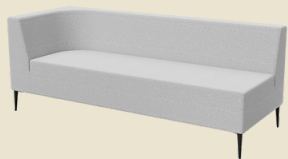

HAV-SB-3SL

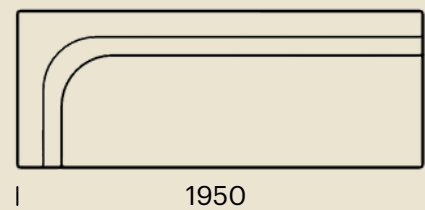
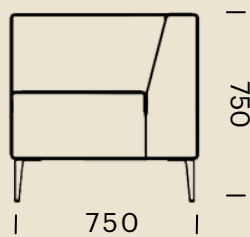

3 Seater with Right Arm

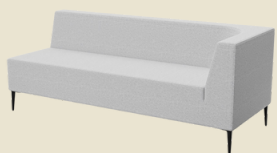

HAV-SB-3SR

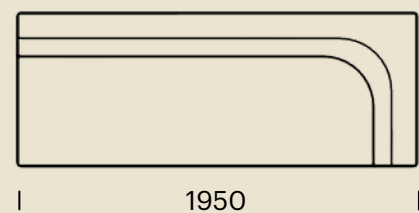
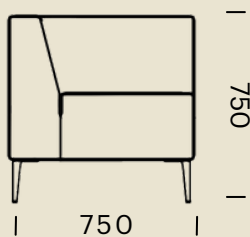

DIMENSIONS (MM) - HAVEN MEDIUM BACK

1 Seater Straight



HAV-MB-1SST

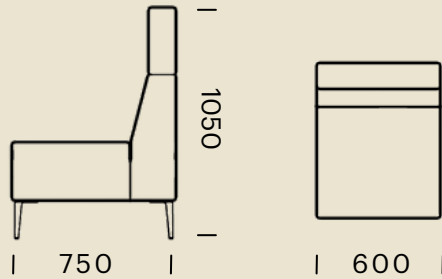

90 Degree Corner



HAV-MB-CNR

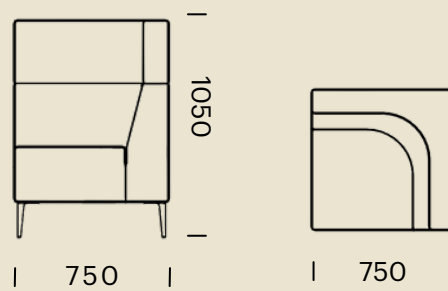

45 Degree Concave



HAV-MB-45CAV

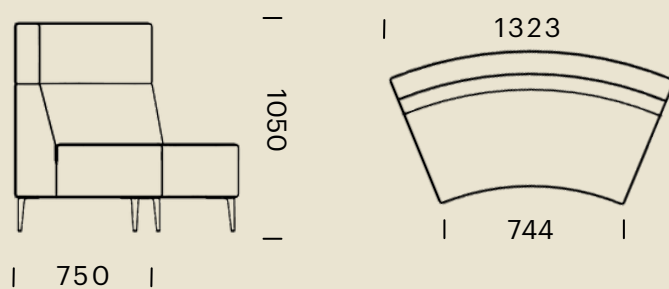

45 Degree Convex

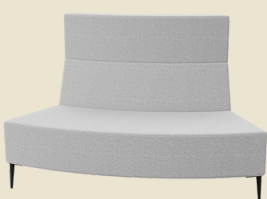

HAV-MB-45CVX

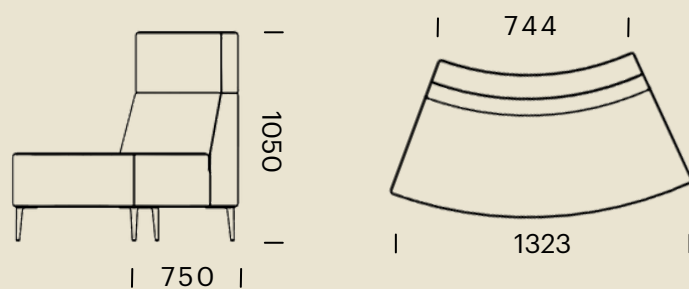

DIMENSIONS (MM) - HAVEN MEDIUM BACK

2 Seater Straight



HAV-MB-2SST

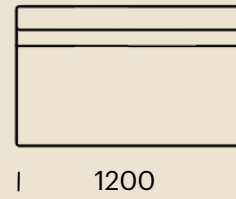

2 Seater with Left & Right Returns

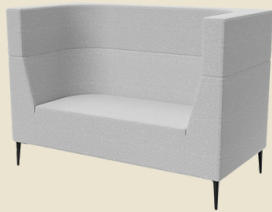

HAV-MB-2SLR

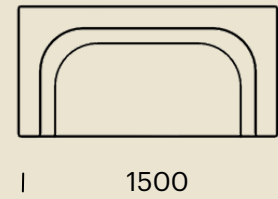
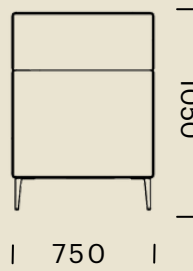

2 Seater with Left Return



HAV-MB-2SL

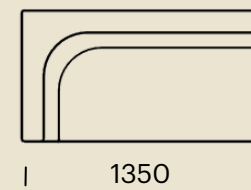

2 Seater with Right Return



HAV-MB-2SR

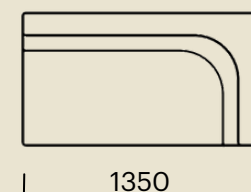

DIMENSIONS (MM) - HAVEN MEDIUM BACK

3 Seater Straight



HAV-MB-3SST

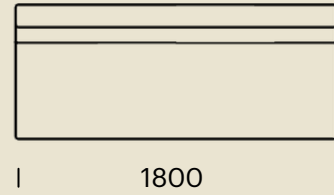

3 Seater with Left & Right Returns

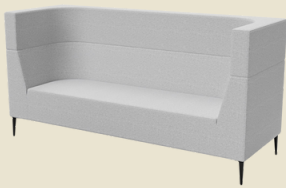

HAV-MB-3SLR

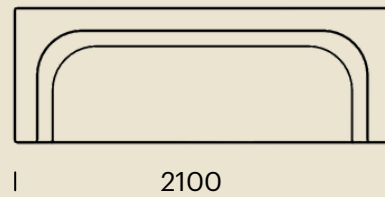

3 Seater with Left Return



HAV-MB-3SL

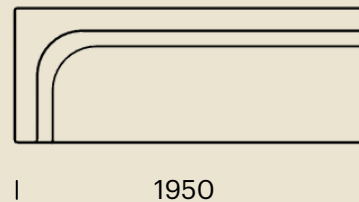

3 Seater with Right Return



HAV-MB-3SR

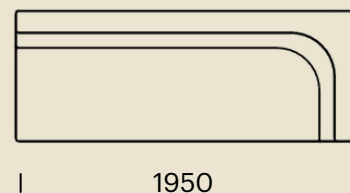

DIMENSIONS (MM) - HAVEN TALL BACK

1 Seater Straight



HAV-TB-1SST

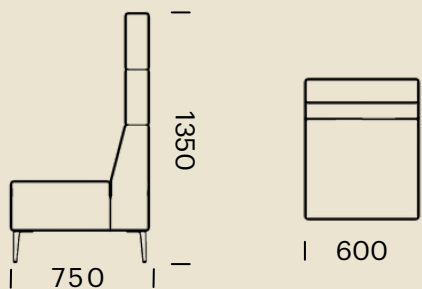

90 Degree Corner



HAV-TB-CNR

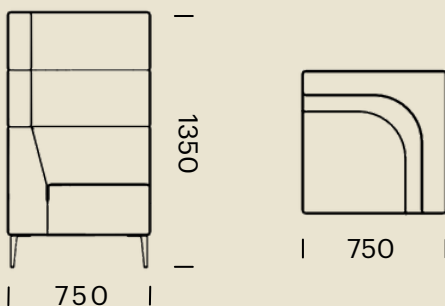

45 Degree Concave



HAV-TB-45CAV

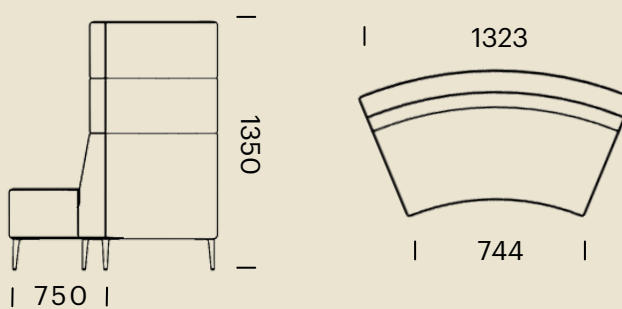

45 Degree Convex

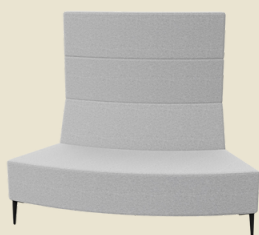

HAV-TB-45CVX

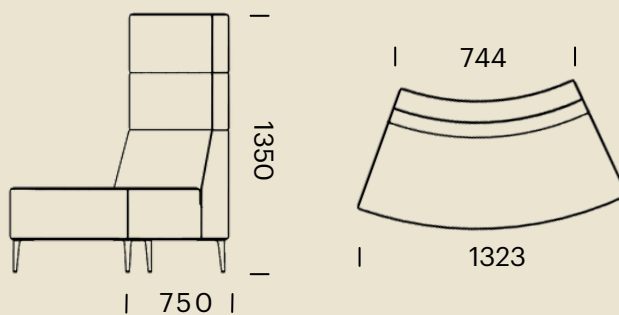

DIMENSIONS (MM) - HAVEN TALL BACK

2 Seater Straight



HAV-TB-2SST

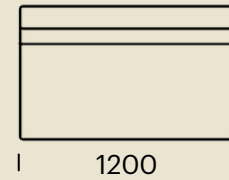
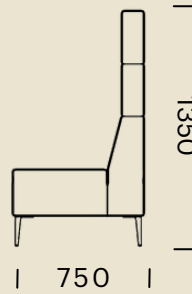

2 Seater with Left & Right Returns



HAV-TB-2SLR

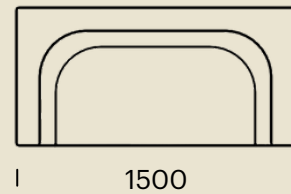
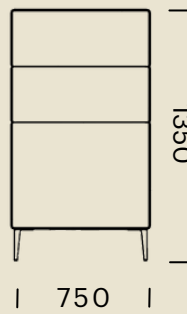

2 Seater with Left Return



HAV-TB-2SL

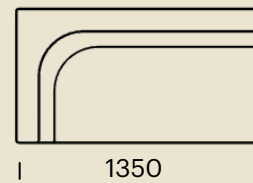
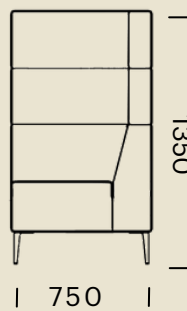

2 Seater with Right Return



HAV-TB-2SR

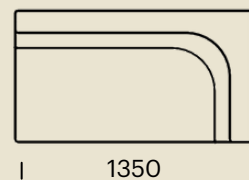
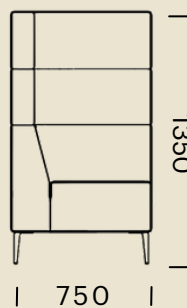

**DIMENSIONS (MM) -
HAVEN TALL BACK**

3 Seater Straight



HAV-TB-3SST

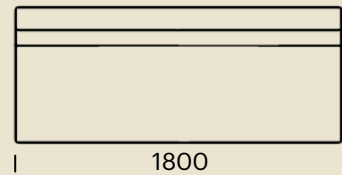
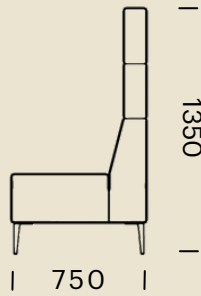

3 Seater with Left & Right Returns



HAV-TB-3SLR

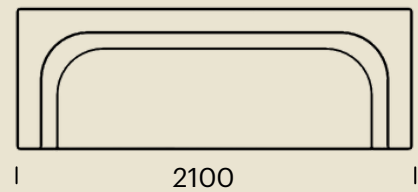
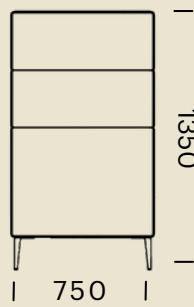

3 Seater with Left Return

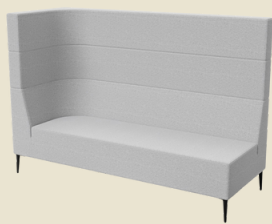

HAV-TB-3SL

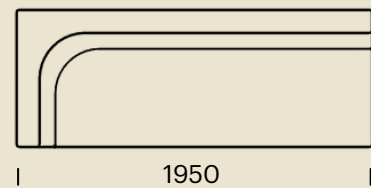
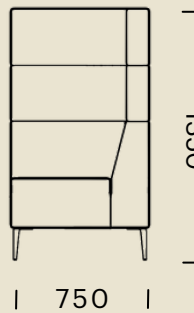

3 Seater with Right Return



HAV-TB-3SR

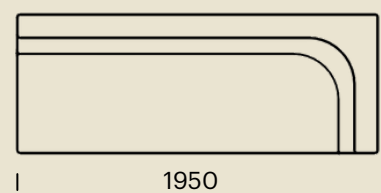
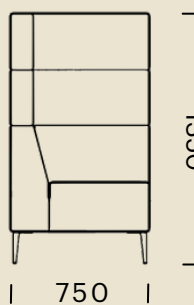

DIMENSIONS (MM) - HAVEN BOOTH 4 PERSON

Booth Standard Back 4
Person



HAV-SB-4PBTH

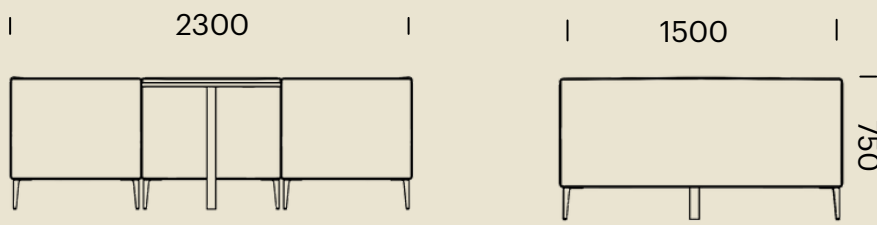

Booth Medium Back
4 Person



HAV-MB-4PBTH

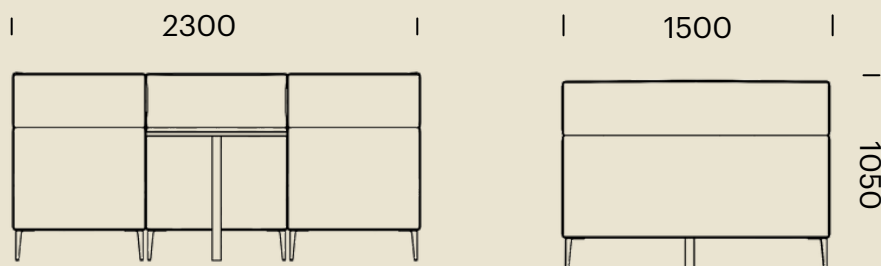

Booth Tall Back
4 Person



HAV-TB-4PBTH

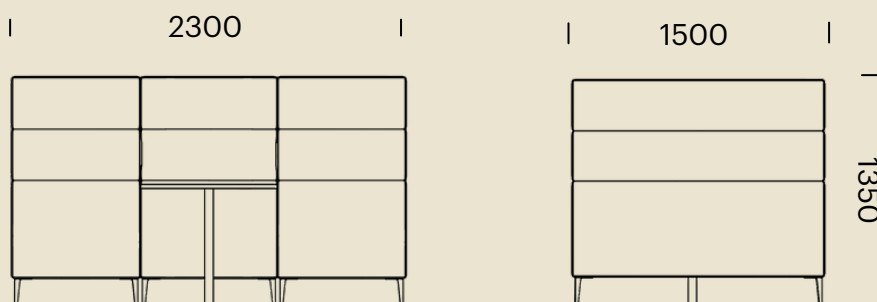

DIMENSIONS (MM) - HAVEN BOOTH 6 PERSON

Booth Standard Back 6
Person

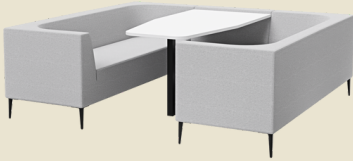

HAV-SB-6PBTH

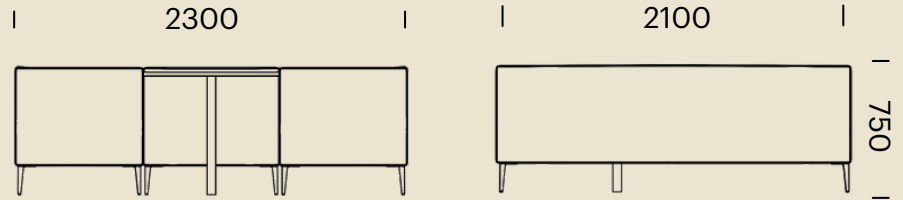

Booth Medium Back
6 Person



HAV-MB-6PBTH

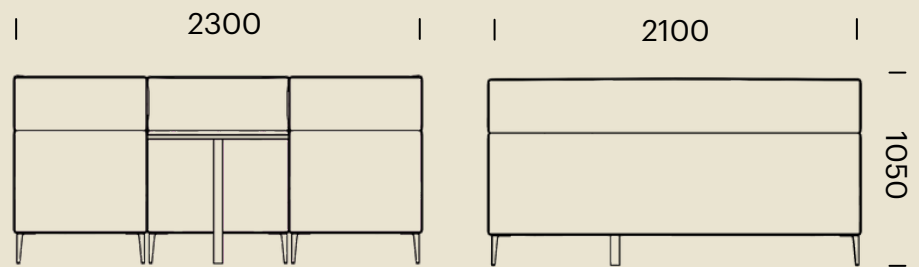

Booth Tall Back
6 Person



HAV-TB-6PBTH

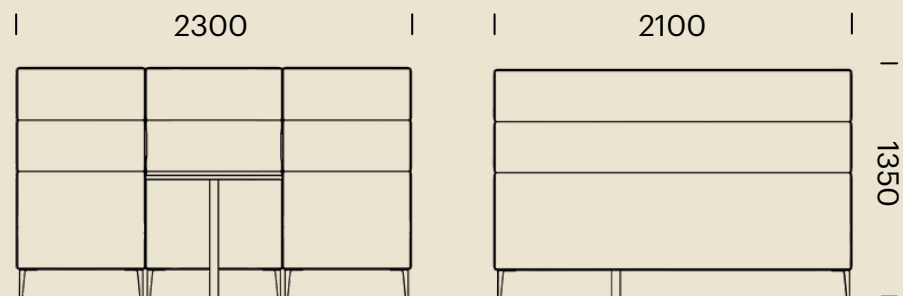

DIMENSIONS (MM) - HAVEN OTTOMANS

Ottoman 1 Seater Straight

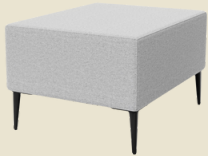

HAV-OTT-1SST

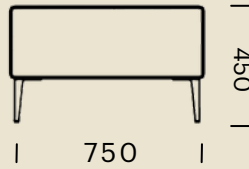

| 600 |

Ottoman 2 Seater Straight

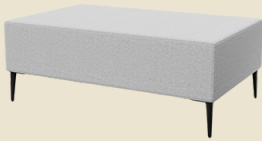

HAV-OTT-2SST

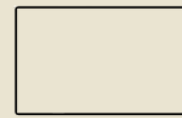
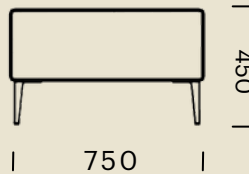

| 1200 |

Ottoman 3 Seater Straight

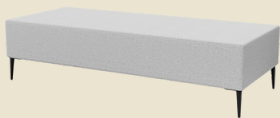

HAV-OTT-3SST

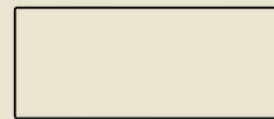
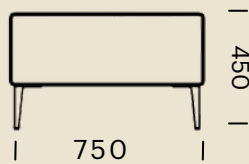

| 1800 |

Square with Tabletop

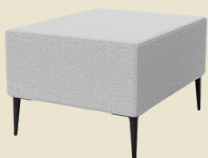

HAV-OTT-SQTT

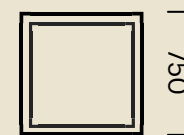
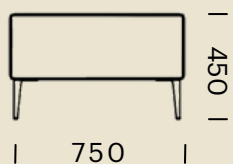

| 750 |

| 750 |

DIMENSIONS (MM) - HAVEN OTTOMANS

Ottoman 90 Degree Corner



HAV-OTT-CNR

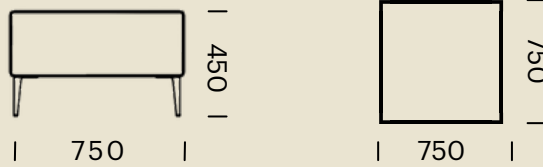

Ottoman 45 Degree Curve



HAV-OTT-45CAV

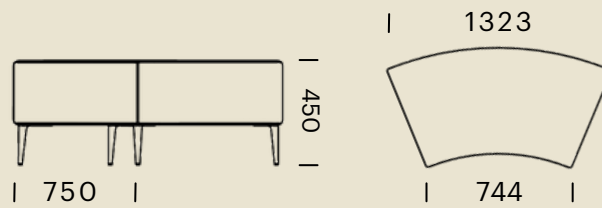

OPTIONS

Rear Bench 45 Degree Concave Tall Back



HAV-OPT-RB45CAV

- Option for Tall Back only
- 25mm Thickness, 300mm depth
- Placed at 1050mm Height

Finishes: House Laminates Range CAT A / B

Rear Bench 45 Degree Convex Tall Back



HAV-OPT-RB45CVX

- Option for Tall Back only
- 25mm Thickness, 300mm depth
- Placed at 1050mm Height

Finishes: House Laminates Range CAT A / B

Rear Bench Straight Tall Back



HAV-OPT-RBST

- Option for Tall Back only
- 25mm Thickness, 300mm depth
- Placed at 1050mm Height

Finishes: House Laminates Range CAT A / B

GPO Unit Front or Rear



HAV-OPT-PWR-F - Option add power to front
HAV-OPT-PWR-R - Option add power to rear

- White or Black

Leads to power source may be visible depending on location.
Floorbox not supplied by Burgtec.





Care and Maintenance

Fabric

For a general clean, regular dusting and vacuuming removes any loose particles and stops dirt from entering the weave and breaking down the fibres. When necessary, the upholstery should be gently wiped with a clean cloth, dampened with warm soapy water.

Immediately dry with a clean and dry non-abrasive cloth. Do not use strong or abrasive cleaning fluids or detergents, as these may affect the colour and finish of the fabric. Upholstery can be professionally dry-cleaned if required. For best care and maintenance results please follow manufacturer's instructions

Leather, Vinyl, PU & Faux Leather

Periodically dust with a clean, dry soft cloth. Do not expose your Chairs to prolonged Sunlight or other heat sources as this may cause fading. Avoid extremes of Humidity. For Dried Soiling: Gently brush with a soft brush or gently clean with a vacuum cleaner. For Wet Soiling and deep cleaning: Gently remove the excess substance from the surface with absorbent paper. With a clean cloth soaked in a mild soap solution, gently remove the stain. Do not soak the surface, dry and buff immediately with a clean cloth. For best care and maintenance results please follow manufacturer's instructions.

Chrome, Anodised, Polished or Powdercoated Metal Surfaces

Clean with a damp, soft cloth or sponge using lukewarm soapy water. Strong detergents which contain bleach, acid or have an abrasive effect (such as scouring creams) should be avoided. Sponges and scourers made from synthetic fibres or metal which may leave permanent scratches on the surfaces should also be avoided. Ensure product is dried with clean fibre-free cloth after washing.

Warranty Information

Haven Lounges have a 10 Year Warranty. Burgtec promises the original purchaser, at our option, to repair or replace any of the said product or component thereof, subject to normal commercial use, that is defective in material or workmanship for the time period offered on the product from date of purchase. To view the full warranty statement for Haven please go to burgtec.com/haven.



Sydney
Canberra
Melbourne
Brisbane
Newcastle
Perth

